

Dynamic design of the foundation of reciprocating machines for offshore installations – case study

by:

Dr.-Ing. Jan Steinhausen

KÖTTER Consulting Engineers KG

Rheine, Germany

**5th Conference of the EFRC
March 21th / 23th, 2007, Prague**

Abstract:

The installation of large and heavy reciprocating machines on offshore constructions demands specific requirements in the design of the foundation with respect to vibrations. Because the use of those piston engines implies high dynamic loads at the substructure of offshore systems, special measures are required. This paper shows how problems can be avoided by applying a detailed vibration engineering design. An offshore project in the German North Sea involving the installation of three heavy reciprocating mud pumps is taken as an example. It is demonstrated how vibration engineering aspects can be considered within a project at the very beginning. The developed installation concept and its specific technical implementation at the construction are part of this paper.

1 Introduction

For the foundation of heavy reciprocating machines at offshore platforms one has to keep an particular eye on the dynamic loads which will be induced into the substructure below the installation. Normally, block foundations made of concrete cannot be used because of their heavy weight and shortage of space on site. This paper presents the vibration engineering design for the example of the foundation of three reciprocating mud pumps on an offshore platform.

On “Mittelplate” (see figure 1), the artificial platform for drilling and mining of petroleum in the German wadden sea, a new drilling rig for increasing the exploration capacity has been planned since 2003. The drilling rig of type T150 has been built upon the existing skidding beams (of the former drilling rig) since August 2005 and has been set into operation in December 2005.



Figure 1: The drilling and mining platform „Mittelplate” in the state with the old drilling rig.

The studies in the run-up to the project resulted in minimizing the weight of the drilling rig which moves on the skidding beams, see figure 3. For that reason, the idea was born to relocate the mud tanks, the pump installation, the silos for auxiliary flushing and parts of the electrical installation (SCR-unit) above the area of the “Fangedamm”. The “Fangedamm” is placed in the west of the platform. Its task is to absorb the water wave energy during heavy weather and to protect the “Mittelplate”. For the relocation of these units the “Fangedamm” should be covered with a concrete slab founded with piles into the wadden sea. Figure 2 presents the planned installation with the pump house in the middle of the slab above the “Fangedamm”. In order to minimize the transmission of vibrations due to the operation of the three mud pumps (power 2,200 hp each) to other units and especially to the sensitive SCR-unit, the vibration engineering aspects have been considered from the very beginning of the construction.

2 Feasibility analysis

For the basic design in the run-up to the project in 2003 first computations should investigate the basic vibration behaviour of the pump installation.

2.1 Modelling

For the setup of the computational model (Finite-element-method) the new platform construction (slab) above the „Fangedamm“ has been considered as a plane construction consisting of prefabricated elements of reinforced concrete. The interconnections between the elements are considered as monolithic (rigid). The concrete slab is founded with steel piles into the ground of the wadden sea. Figure 3 shows the design of the slab and the pile foundation with the positions of the piles below the slab.

The basic concept of the vibration insulation of the pump house provides a decoupling of the platform areas in the north and in the south. This decoupling is obtained by slits in the slab, see figure 9. Hence, the area of the pump house foundation can be treated separately. Therefore, the installation of the reciprocating machines has been modelled for eight rows of the piles between the axes C and F, see figure 4.

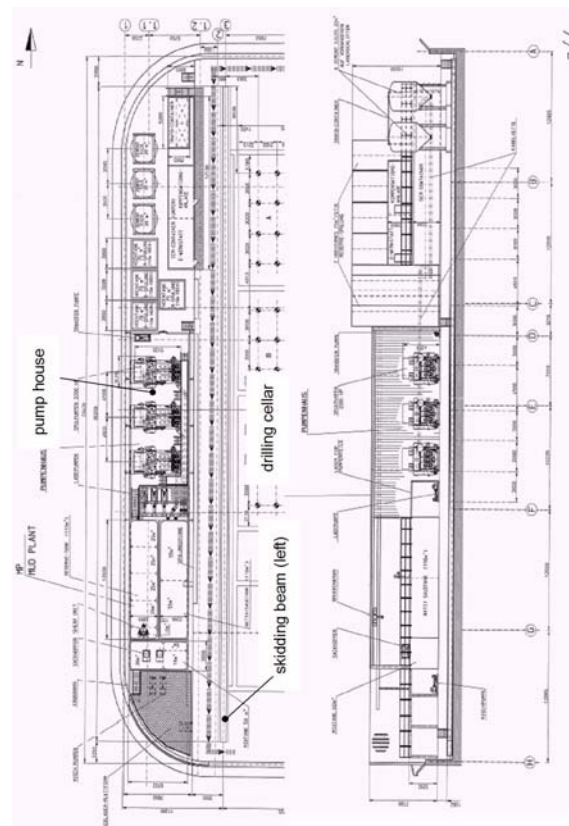

Figure 2: Application areas of the new platform above the „Fangedamm“, left: plan, right: side view.

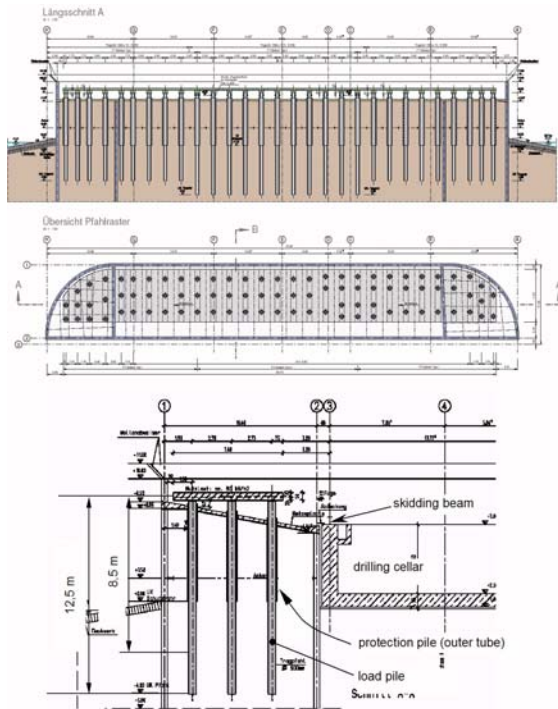

Figure 3: Pile foundation design for the new platform above the “Fangedamm”, top: section in north-south direction, middle: top view of slab (grey) with pile grid, bottom: section (in east-west direction) of the slab and pile foundation.

For a first design of the pile foundation steel pipes with a diameter of 500 mm, a thickness of 10 mm and a length of 12.5 m have been considered. The outer piles (protection piles, diameter 700 mm) should protect the inner piles – the load piles – against the wave impact on the “Fangedamm”. They do not have any contact to the load piles. Therefore, they are not involved in the considerations here.

For a first evaluation of the foundation the (elastic) bedding of the piles has been substituted by a fixed length of 8.5 m from the top to the foot of the pile, see figure 3. There are three piles planned in a row in east-west direction. Each pile foot is considered as totally fixed.

The mud pumps are triplex-type reciprocating pumps, type 7.5”x14” / 2200 HP, manufactured by WIRTH. The weight mass of 46 tons of each machine has been distributed (lumped mass) according the fixation positions of the skid onto the slab of the FEM-model. The speed of the pumps is within the range from 0 rpm to 110 rpm. The maximum dynamic load reactions arise at the 1st order due to the free mass moments of the machines (1st order: 0 – 1.83 Hz).

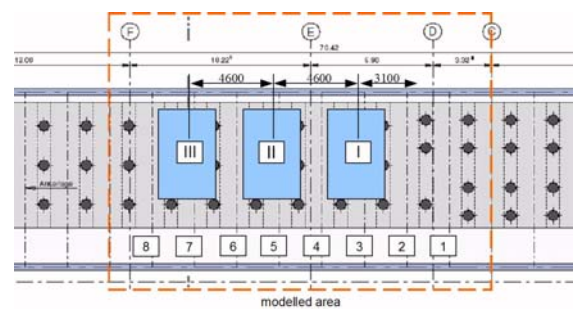

Figure 4: Positions of the mud pumps and alignment of the piles, first design.

2.2 Modal analysis

A modal analysis has been carried out for a primary assessment of the dynamic behaviour of the first construction design. The results indicate the three lowest natural frequencies are within the 1st order frequency range (0 – 1.83 Hz), thus in the range of the largest reaction load. Figure 5 presents the natural mode shapes up to about 20 Hz. The 1st and 2nd mode shape indicate each primarily a translation of the concrete slab, the 3rd indicates a torsional movement (with vertical axis). The 4th mode shape indicates a deformation of the concrete slab itself.

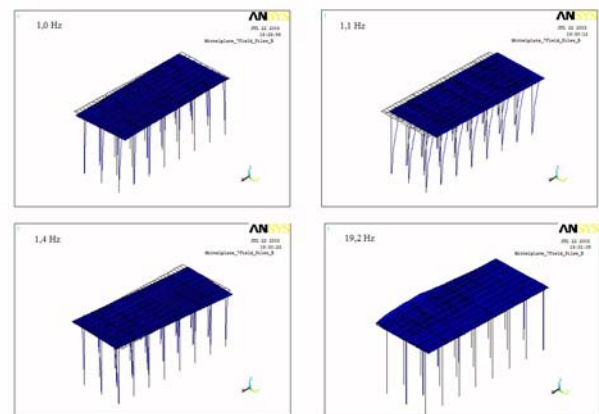

Figure 5: Natural mode shapes of the first design of the pump installation, undeformed: unfilled grid, deformed: filled grid.

2.3 Response analysis at operating conditions

For a first assessment of the forced vibration level during operation of the pumps the exciting mass moments within the 1st order frequency range have been obtained from the data specified by the manufacturer. The exciting moments are applied on the model with respect to the location of the crank shaft of each pump, see figure 6. The oscillating moments represent a harmonic excitation with direction normal to the slab. The direction of the rotating moments rotates with the rotating frequency in the y-z plane. All moments are acting

synchronously (no phase shift). Thus, the worst case is considered, when all pumps are in operation. The critical damping ratio is set to 0.025 for the complete frequency range. The simulated results show that the vibration velocity on the concrete slab achieves in case of resonance up to 70 mm/s (target is: 3 mm/s rms) in horizontal direction.

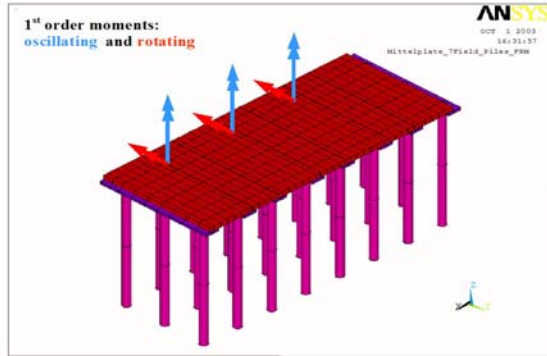

Figure 6: Applied moments for first response analysis.

In order to avoid exceeding resonance vibrations within the frequency range of the 1st order, the target has been to shift the 1st (lowest) natural frequency of the complete construction above 3 Hz. Therefore, the slab of the pump house should be connected with a steel-framework to the massive drilling cellar (reinforced concrete), see figure 7. First calculations for this 2nd design indicated the lowest natural frequency far above the critical exciting range of the 1st order of the pump speed. Thus, exceeding resonance vibrations are eliminated within this frequency range.

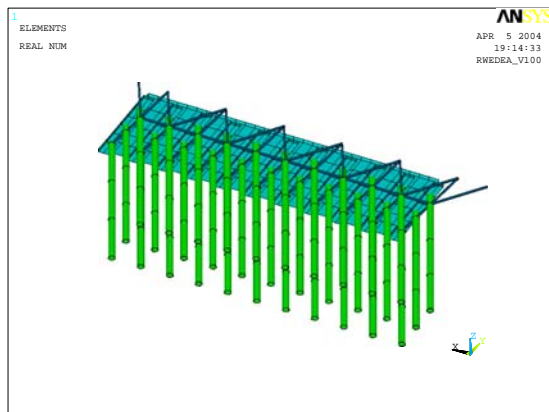

Figure 7: FEM-model of the 2nd design of reciprocating pump foundation, connection of the slab of the pump house to the massive drilling cellar by framework construction.

However, the natural frequencies of the construction (2nd design) will be excited by the load reactions of the 2nd, 3rd and other higher orders. For a more accurate estimation of the expected

vibration level (during operation of the pumps) the exciting reaction forces have been determined by measurements on the test bench at the manufacturer. For this, a single of the reciprocating pump has been set up on especially prepared steel profiles (beams) on which strain-gauges have been applied. The forces transmitted to the ground have been measured at selected locations of the skid. The forces have been determined in x-, y- and z-direction. The maximum forces have been detected at 110 rpm with maximum load (pressure). For example, figure 8 presents the time-frequency spectrum of the force in y-direction at a selected position on the skid during run up (0 – 110 rpm), steady state (110 rpm) and run down (110 – 0 rpm). Local resonances of the test bench setup can be seen here, too. The relevant frequency range goes up to about 30 Hz. From the measured forces (at different locations) the exciting forces and moments of the reciprocating machine for the further calculations have been derived.

The reaction forces and moments have been applied to the FEM-model of the 2nd design. The results of the response analysis show that even by the higher order forces (moments) exceeding vibrations of the slab can be excited (resonance cases). To take this into account, the resonance vibrations should be decreased by special damper elements and should be integrated in the framework design, see figure 11. The selected dampers are acting as viscous dampers [3].

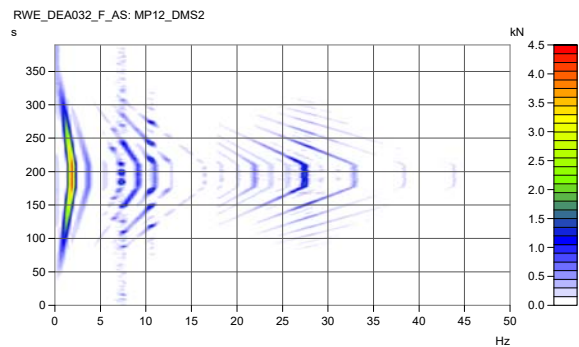

Figure 8: Time-frequency spectrum, example of force in y-direction (at a selected position) during variation of the pump speed: 0 - 110 - 0 rpm.

2.4 Result of the feasibility analysis

The basic computations for the mud pump foundation reveal that the critical exciting frequency can be shifted above the critical exciting frequency range (1st order) by stiffening the structure with a steel-framework connected to the drilling cellar. The damping of the expected higher frequency vibrations (structural resonances) will be provided by special dampers. All in all, from the vibration point of view the installation of the reciprocating pumps on the slab above the “Fangedamm” is feasible.

3 Detailed layout – Structural dynamic calculations

The feasibility study was followed by the detailed design of the framework and the damping elements. After completion of the work in the underground at the construction side, the following changes have been found compared to the existing (fundamentals of the calculation) model:

1. Strongly varying lengths of the piles and thus of the penetration depths into the supporting (ground) layer.
2. A change in bedding functions¹⁾ depending on the penetration depth of the piles.
3. A change in position of several rows of pillars made the pillar distance no longer equidistant in north-south direction.

3.1 Measurements to obtain the properties of the construction

To verify the model for the bedding function of the pile foundation, dynamic measurements of the construction properties have been carried out after completion of the bare concrete platform for the pumps (i.e. without the pumps and other constructions on the platform). Following the measurements, the calculation model has been adapted.

Preceding calculations with the original assumptions for the bedding functions have showed that the lower three mode shapes of the concrete platform (placed on piles) can be expected in the frequency range between 2.5 and 3 Hz. Because of this a special unbalance exciter was used during the measurements that excited with an adequate force at frequencies as low as 1 Hz. The filled slits for vibration decoupling at the north and south edge of the concrete platform for the pumps (see figure 9) were emptied. No contact bridges existed with adjoining platforms in the north and the south. The slab for the pumps could thus move freely in horizontal plane.

The FEM-model has been adapted to the measured natural frequencies and damping. Apart from the individual lengths of the piles and their penetration depths, the framework under the concrete platform has also been considered in this adaptation. The adaptation of the bedding function has been carried out on the following parameters:

1. dynamic bedding modulus, $K_{S, dyn}$
2. depth of (the top of) the supporting ground layer, h_{BA}
3. damping in the bedding function, D_S

For the location of the natural frequencies primarily the first two parameters are of importance.

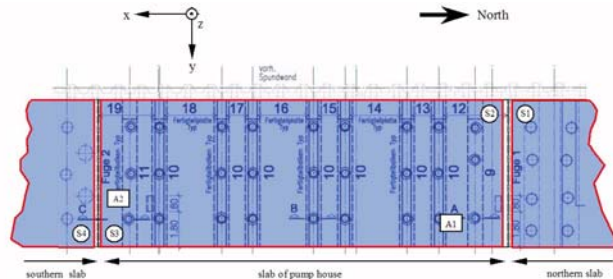

Figure 9: Location of the measurement points S1 to S4 and the locations of the unbalance exciter A1 and A2 (top view of the concrete platform).

3.2 FEM-model of the foundation

For the final model of the construction above the „Fangedamm“ in the vicinity of the pumps eight rows of piles in north-south direction have been taken into account (see figure 10). The concrete plate has been assumed to be monolithic, i.e. with rigid interconnections. The connection of the steel pile heads to the concrete slab has also been assumed to be rigid. The masses of the three Triplex reciprocating pumps have been distributed as four masses per pump (so in total 12 masses) at a height equal to the centre of gravity of the pumps, i.e. at 1.25 m above the centre of gravity plane of the concrete platform (thickness 30 cm).

Figure 10 shows the optimized FEM-model for the pump house including the framework connecting to the drilling cellar and the trusses for the implementation of the dampers. The framework that is connected to the construction above the drilling cellar has been adapted to the real north-south orientation of the pile rows. From several calculations, it has been found that the most favourable position for damping, i.e. the dampers, is under the overhang of the concrete platform.

3.3 Optimization of the framework

To reduce the resonances of the components above the 1st order of the pump speed, dampers have been implemented with almost viscous damping properties. From parameter studies followed a damping specification for the dampers of $d = 500 \text{ kNs/m}$ at 16 Hz.

¹⁾ bedding function = change of the modulus of elasticity of the soil-layer with depth

Within the scope of optimizing the framework several configurations with different stiffness of the framework and number of dampers have been investigated. It has generally shown that for a framework with a higher stiffness the resonance amplitudes have been smaller compared to that of a framework with less stiffness with the same amount of dampers.

The implementation of 8 dampers has been favourable for obtaining a targeted maximum vibration velocity amplitude of 3 mm/s (rms) at the concrete surface under operating conditions. The calculated mode shapes of the optimized installation are depicted in figure 13. The 1st mode shape can be seen primarily as a movement of the concrete platform in x-direction parallel to the drilling cellar. The 2nd mode shape is a rocking and translational mode of the concrete platform into the drilling cellar. The 3rd mode shape is more a torsion mode of the concrete platform. The higher mode shapes are vibrations of the framework.

The results of the vibrational analysis at the operating conditions have showed that with three pumps operating in parallel the targeted vibration velocity of 3 mm/s (rms) is reached. As an example, figure 11 shows the time-frequency-amplitude spectra of the calculated vibrational velocity in y-direction at node 244 (location, see figure 10), where the highest vibration level occurs. The figure shows a resonance at 13 Hz that occurred at a simulated sweep of pump rotation speed up to 110 rpm.

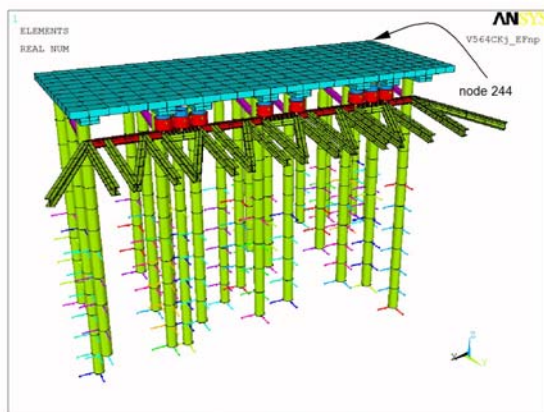

Figure 10: FEM-model of the optimized and realised framework with the 8 damping elements under the concrete platform (slab).

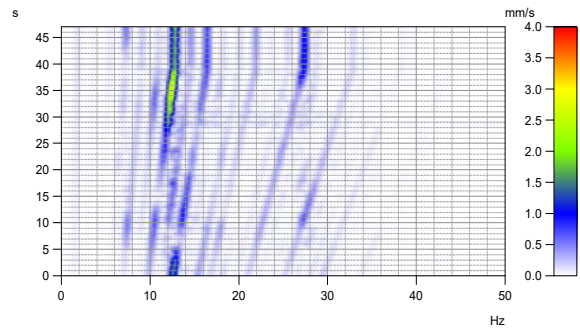

Figure 11: Time-frequency-amplitude spectrum of the calculated vibrational velocity in y-direction at node 244 (max. 3.1 mm/s rms) excitation in y-direction, rotational sweep 90 – 110 rpm.

4 Verification measurements

After completion and start-up of the new drilling rig, the vibrational situation during operation of the pumps was checked by measurements. The vibrations of the construction were measured at several locations at the slab of the pump house and at the neighbouring slabs (north: container, south: tanks). The measurements have showed that the structural vibrations (movements of the slabs) are within the limit of 3 mm/s rms at all operating conditions of the pumps. The slabs north and south of the pump house showed a significantly lower vibration level compared to the slab of the pump house. An excitation of higher resonances at neighbouring slabs could not be identified. Thus, the slits (with filling) are sufficient as vibrational decoupling. All in all, the function of the framework with dampers proved to be very satisfying.



Figure 12: Framework after completion.

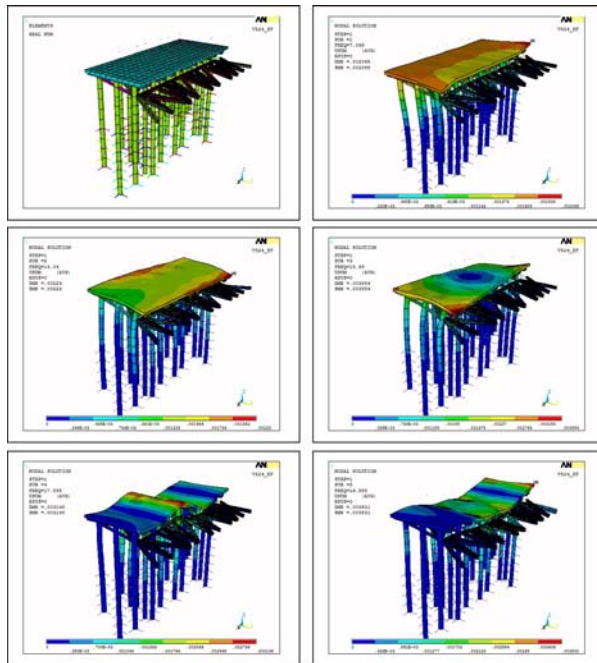

Figure 13: Undeformed model (top left side) and natural mode shapes, minimum displacement: blue, maximum displacement: red, natural frequencies (from left to right and from top to bottom) 7.1 Hz (top right), 13.0 Hz, 15.7 Hz, 17.8 Hz, 19.6 Hz.

5 References

- [1] Riehwein, W.; Lesny, K.; Wiemann, J.: „Nachweise und Sicherheitskonzepte für die Gründung von Offshore-Windenergieanlagen in der Deutschen Bucht“, 2. Symposium Offshore-Windenergie, Bau- und umwelttechnische Aspekte, September 2002, Hannover
- [2] Schaumann, P.; Seidel, M.: „Eigenschwingverhalten von Windenergieanlagen – Berechnungen und Messungen“, Vortrag zur DEWEK 2000, Wilhelmshaven
- [3] Gerb Schwingungsisolierungen, 11. Auflage, Berlin, 2002